

FINESTRE[®]

> SOLUZIONI

Proteggiamo i tuoi ambienti



divisori di protezione
personalizzabili



NODROPLET

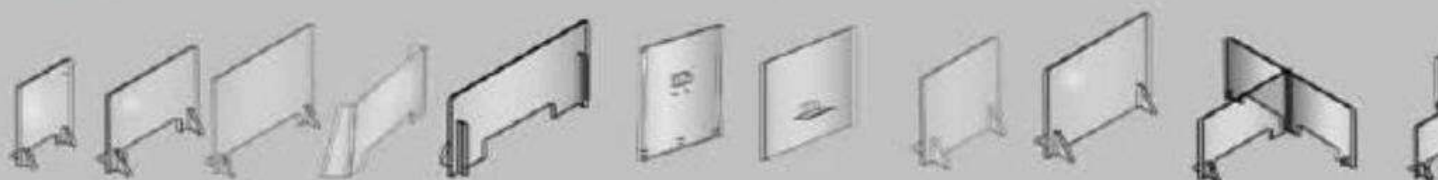

Serie Desk-One

Pag. 1

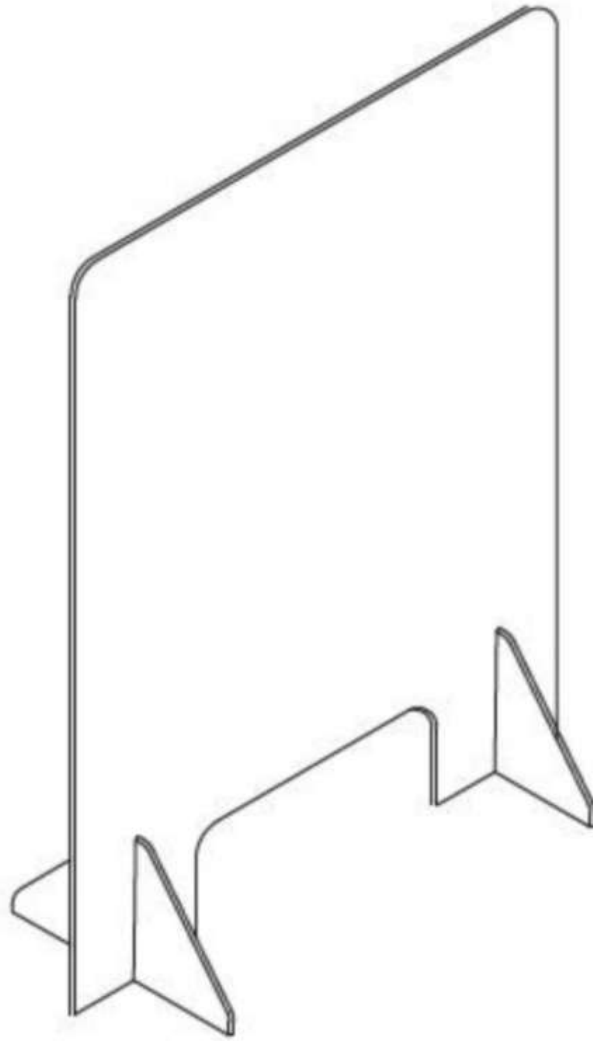

Art.001

FINESTRA
SOLUZIONI

MISURE

● VISTA FRONTALE

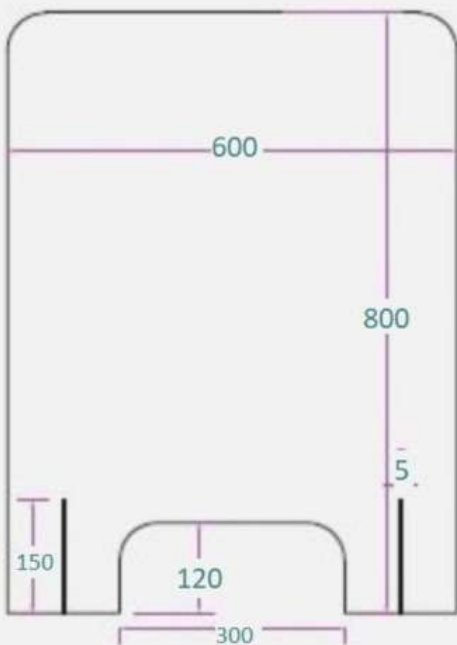

● VISTA LATERALE



Serie Desk-One

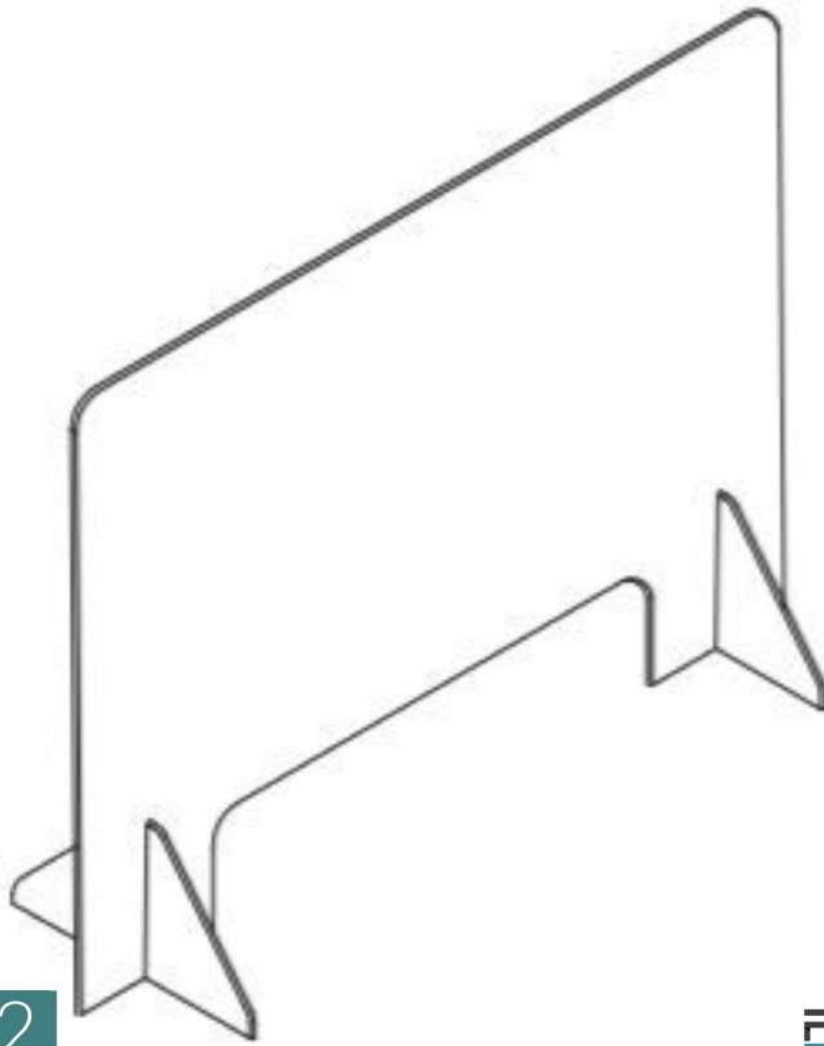

Art.002

FINESTR
>SOLUZIONI

MISURE

● VISTA FRONTALE

● VISTA LATERALE

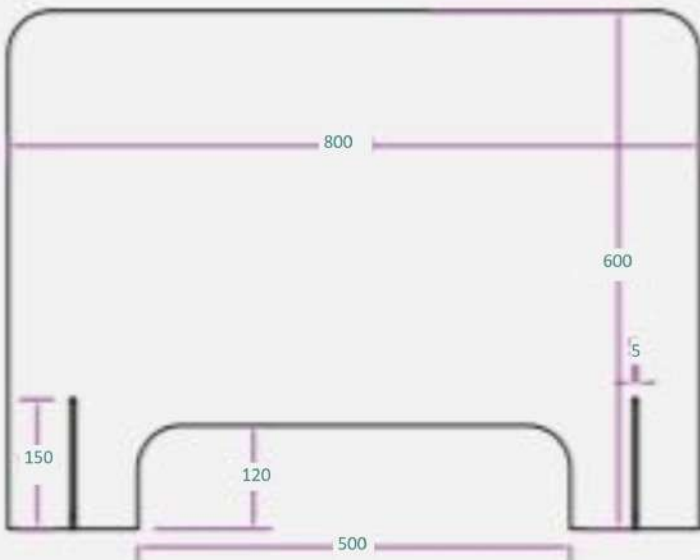

Serie Desk-One

Pag. 3

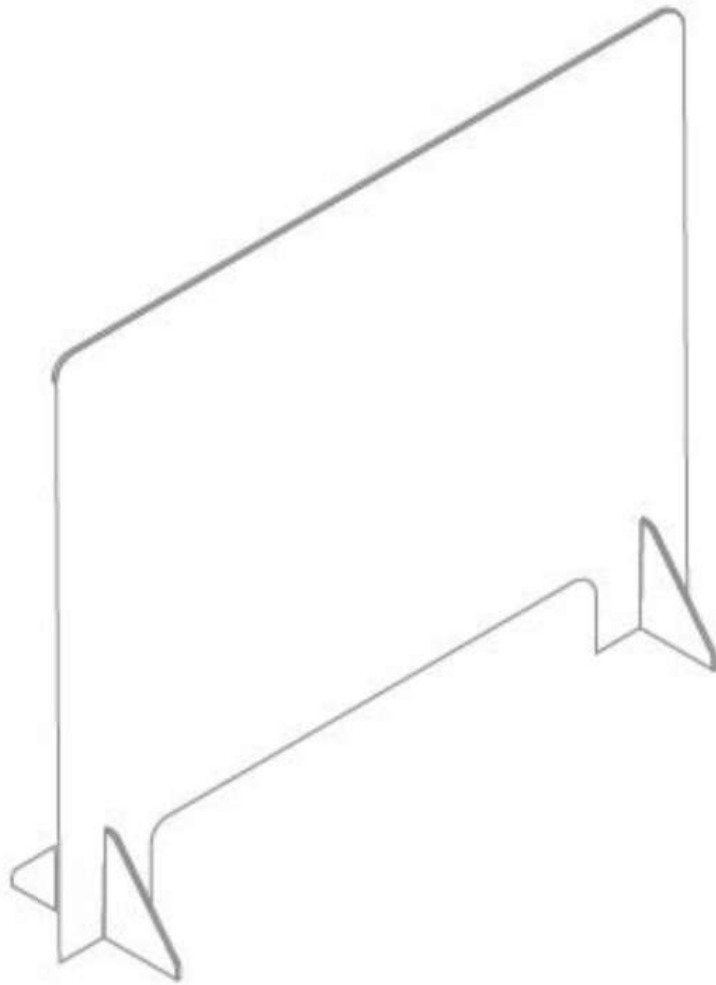

Art.003

FINESTR
SOLUZIONI

MISURE

● VISTA FRONTALE

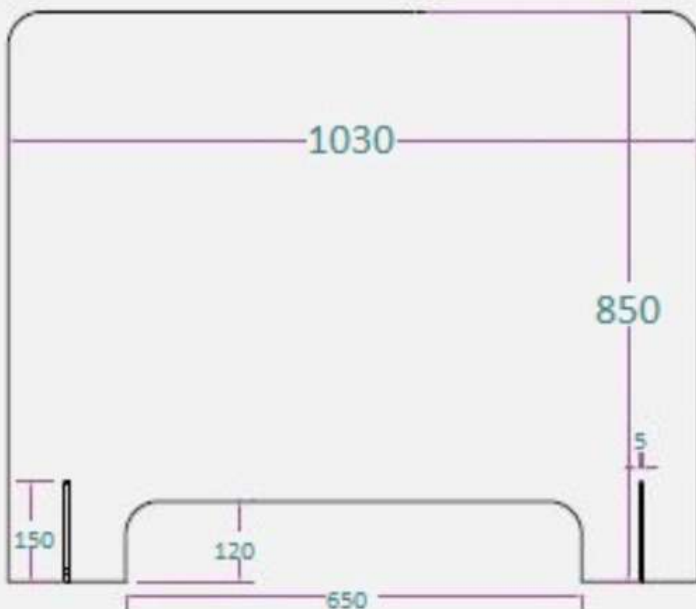

● VISTA LATERALE



Serie Desk-One

Pag. 4

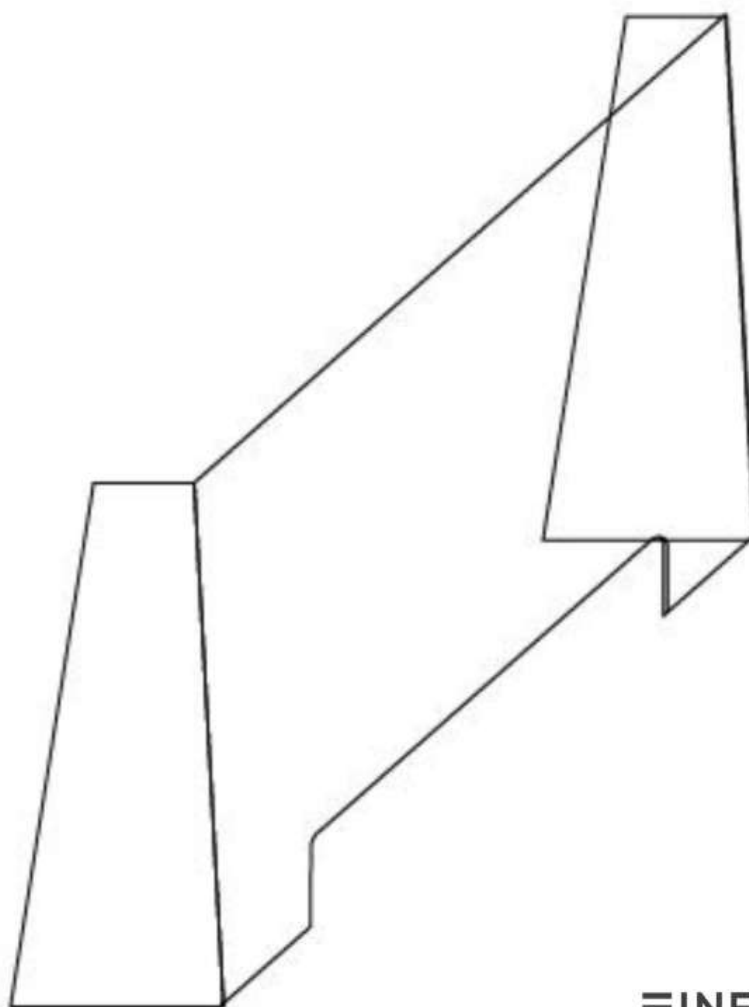

Art.004

FINESTR
SOLUZIONI

MISURE

● VISTA FRONTALE

● SPESSORE PANNELLO 4 mm

● VISTA LATERALE

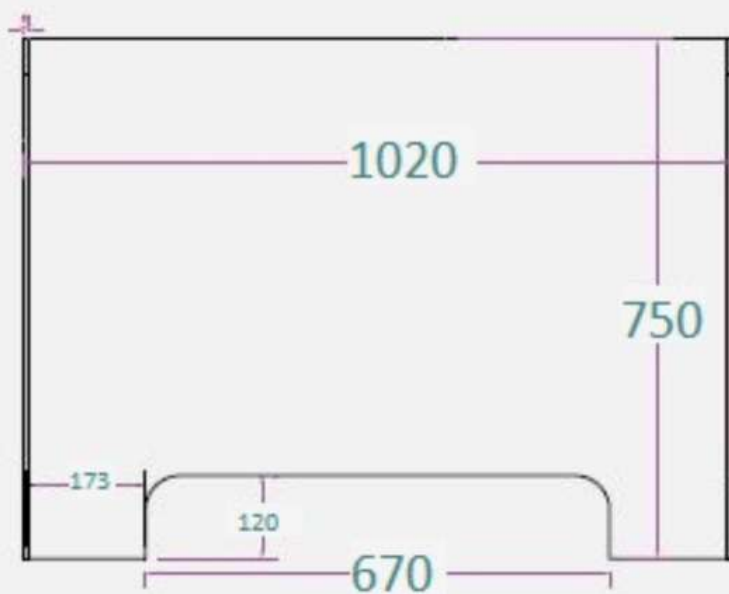

Serie Desk-One

Pag. 5

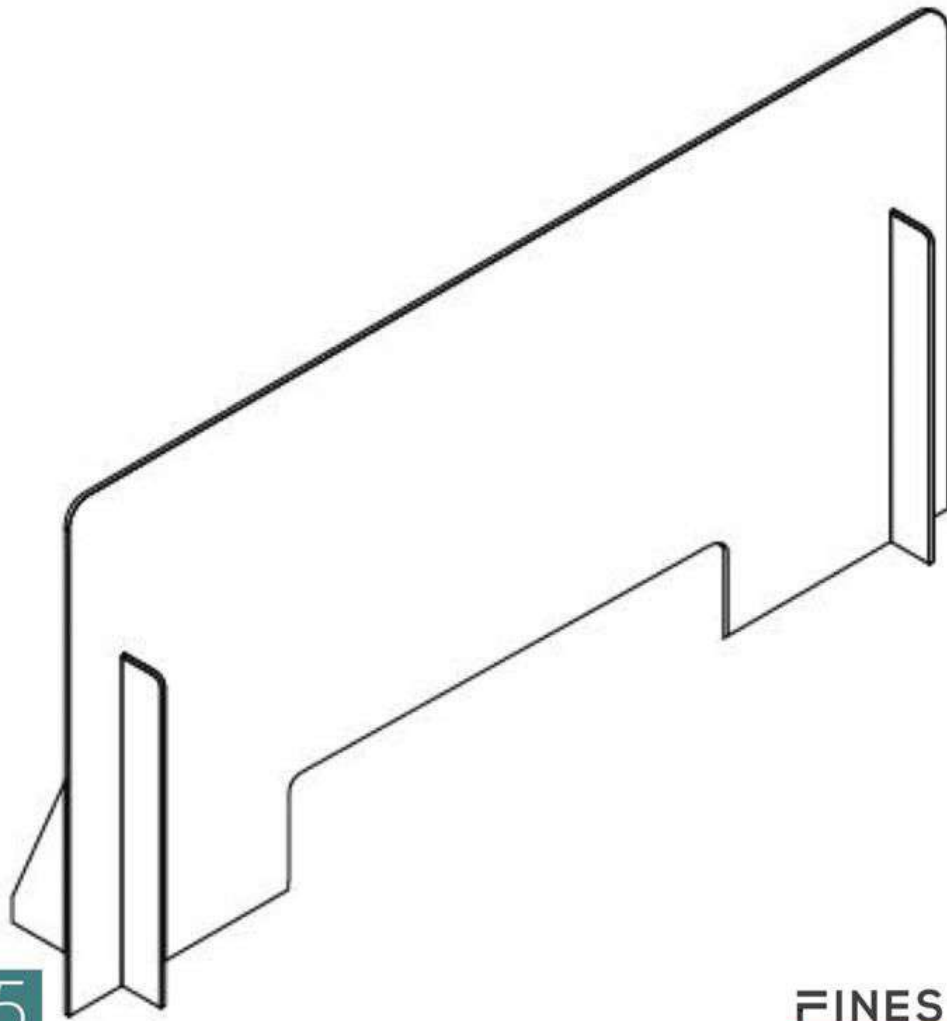

Art.005

FINESTRE
SOLUZIONI

MISURE

● VISTA FRONTALE

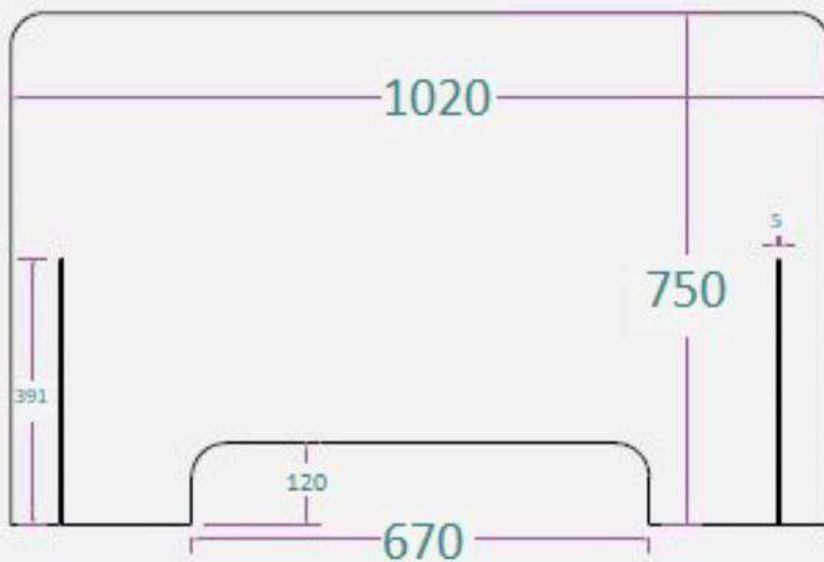

● VISTA LATERALE

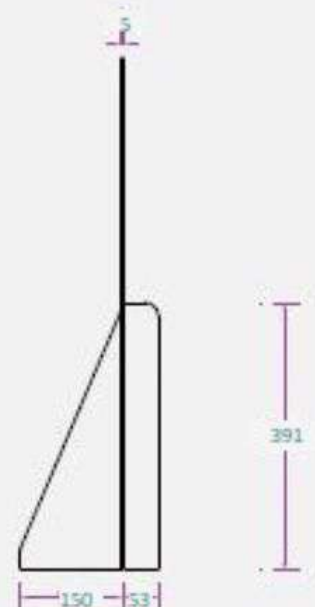

Serie Desk-Closed

Pag. 6

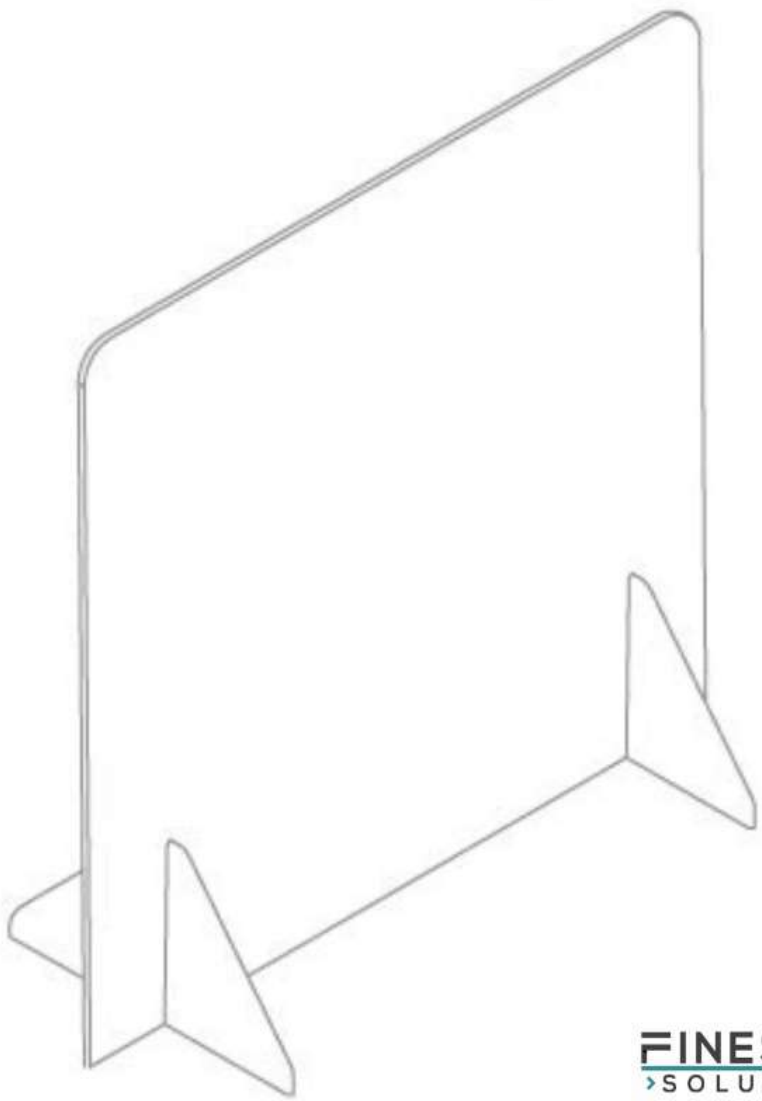

Art.006

FINESTRE
>SOLUZIONI

MISURE

● VISTA FRONTALE

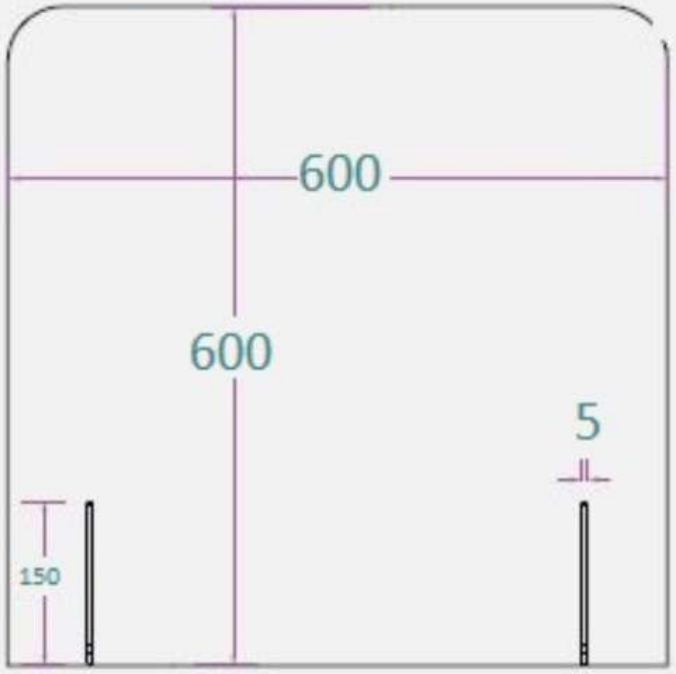

● VISTA LATERALE

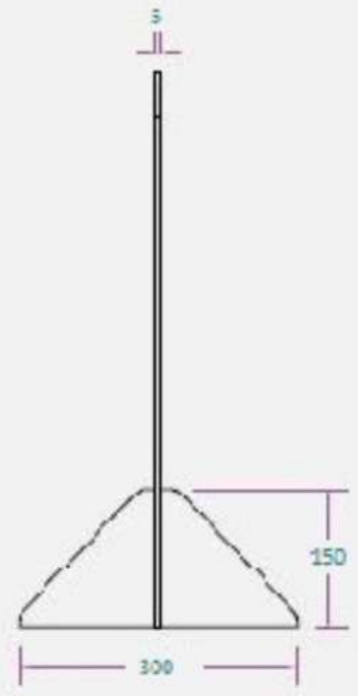

Serie Desk-Closed

Pag. 7

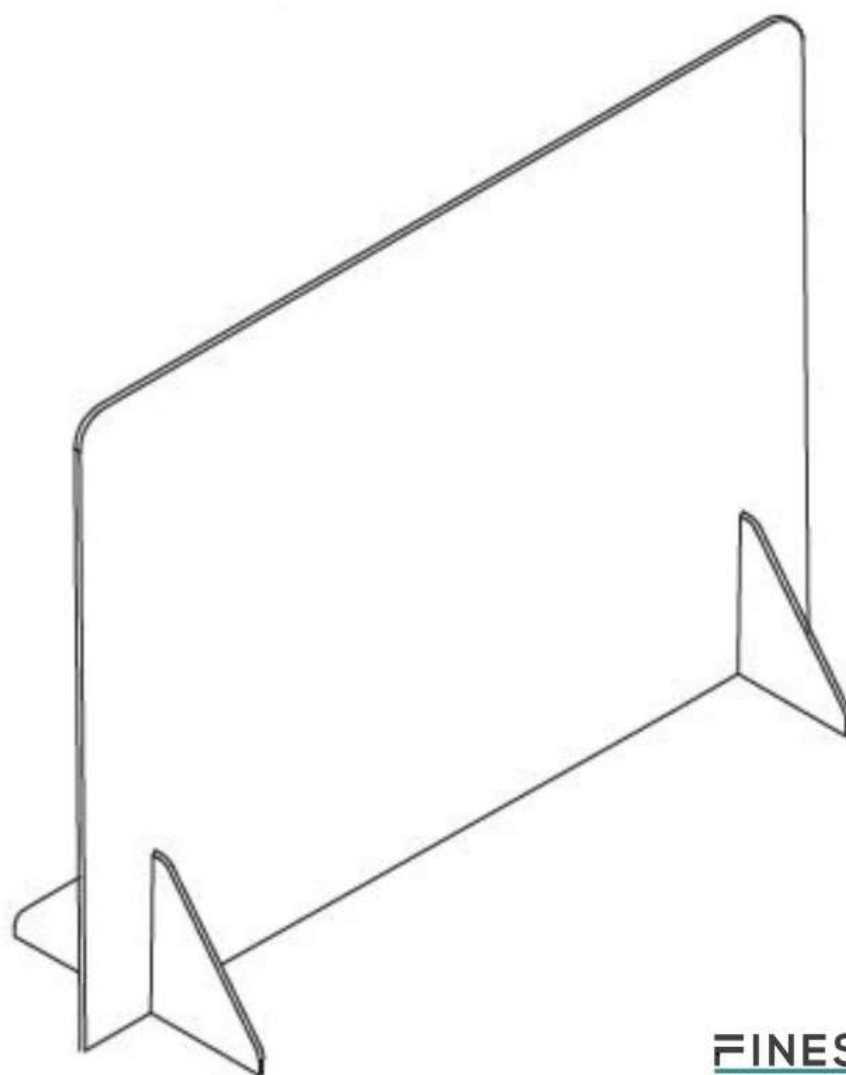

Art.007

FINESTRE
>SOLUZIONI

MISURE

● VISTA FRONTALE

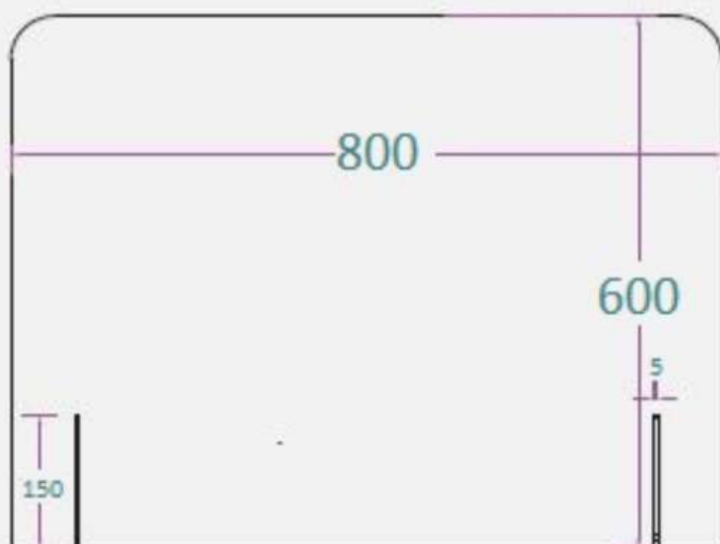

● VISTA LATERALE



Serie Desk-Closed 3

Pag.8

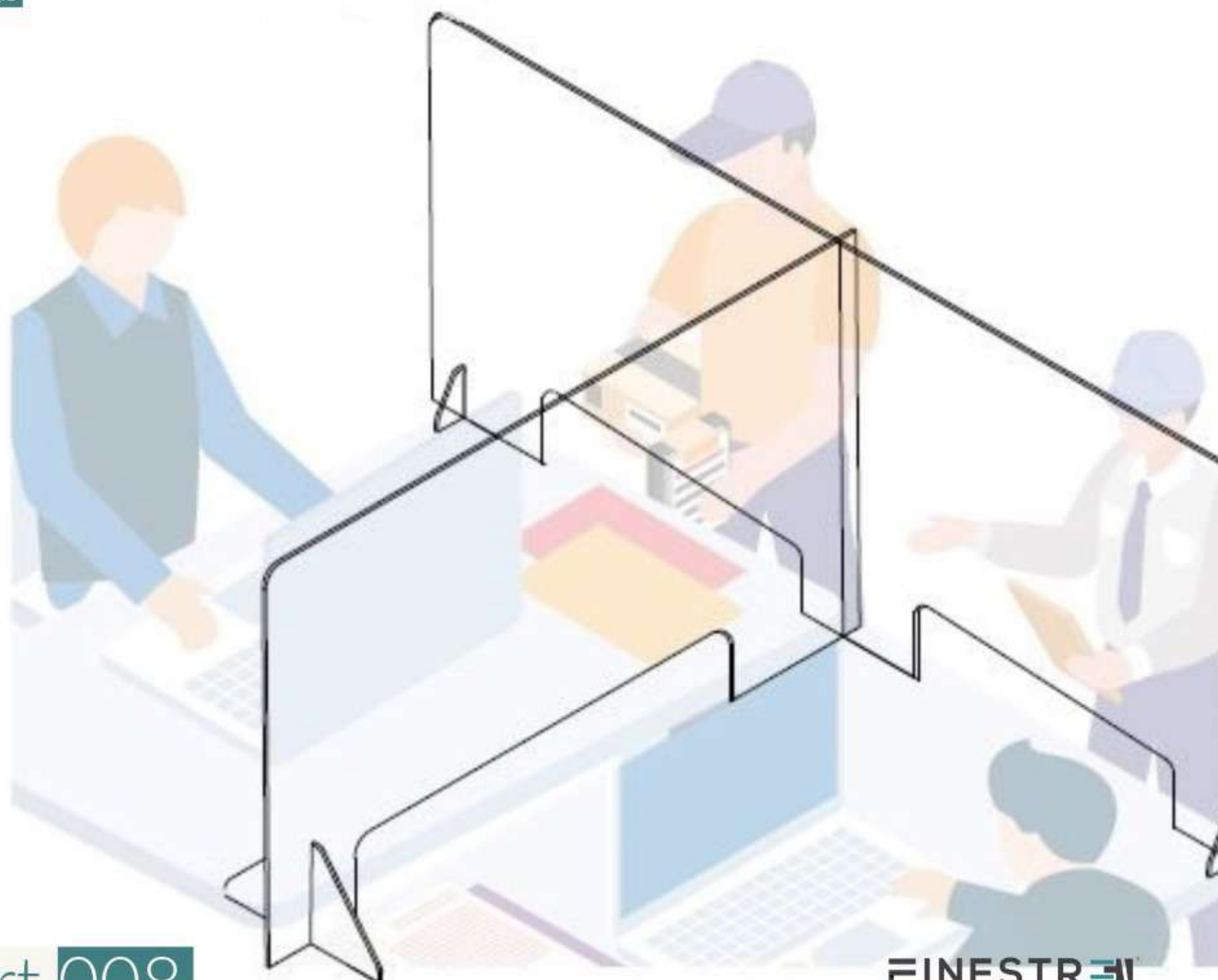

Art.008

FINESTR
SOLUZIONI

MISURE

● VISTA FRONTALE

● VISTA LATERALE

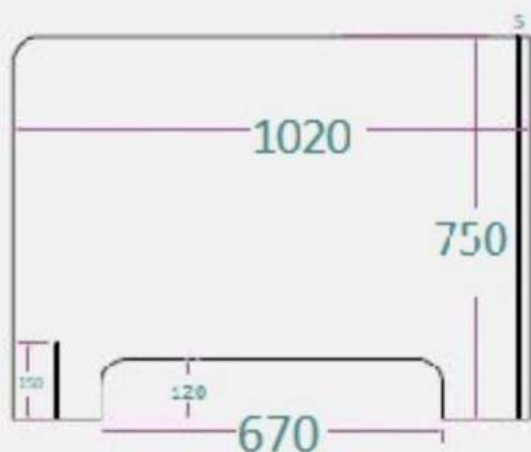

Serie Desk-Closed 4

Pag.9

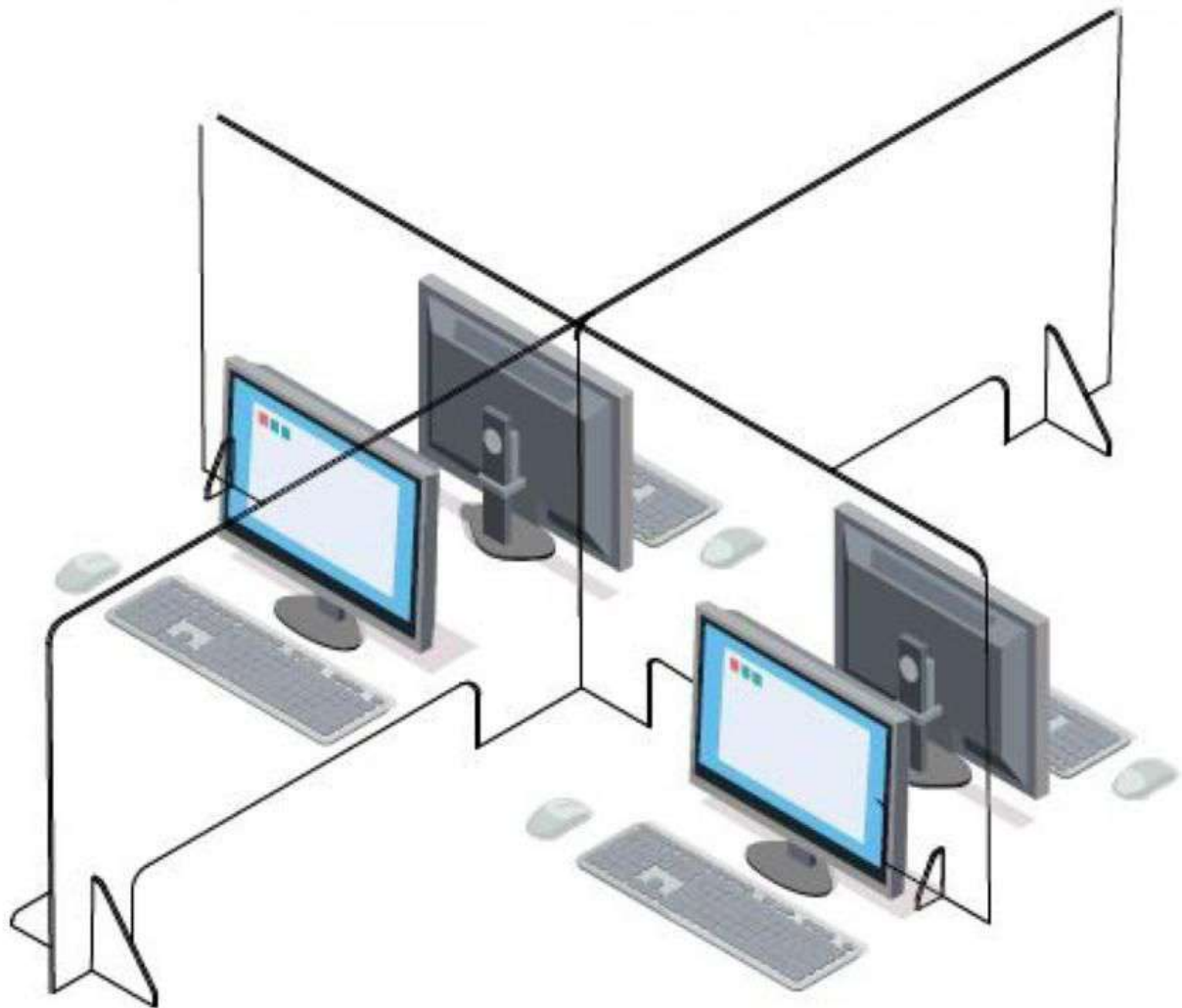

Art.009

FINESTRA
>SOLUZIONI

MISURE

● VISTA FRONTALE

● VISTA LATERALE

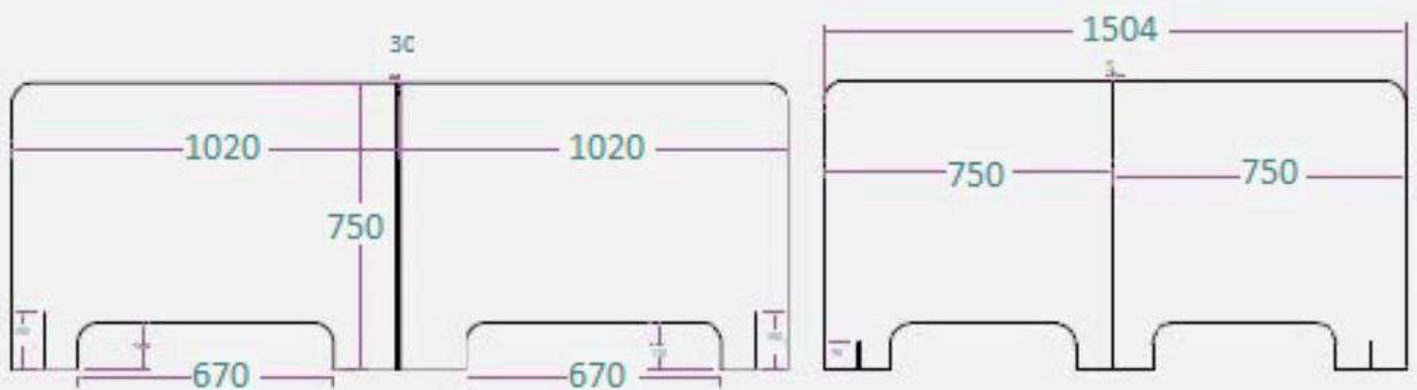

Serie Desk-Business

Pag.10

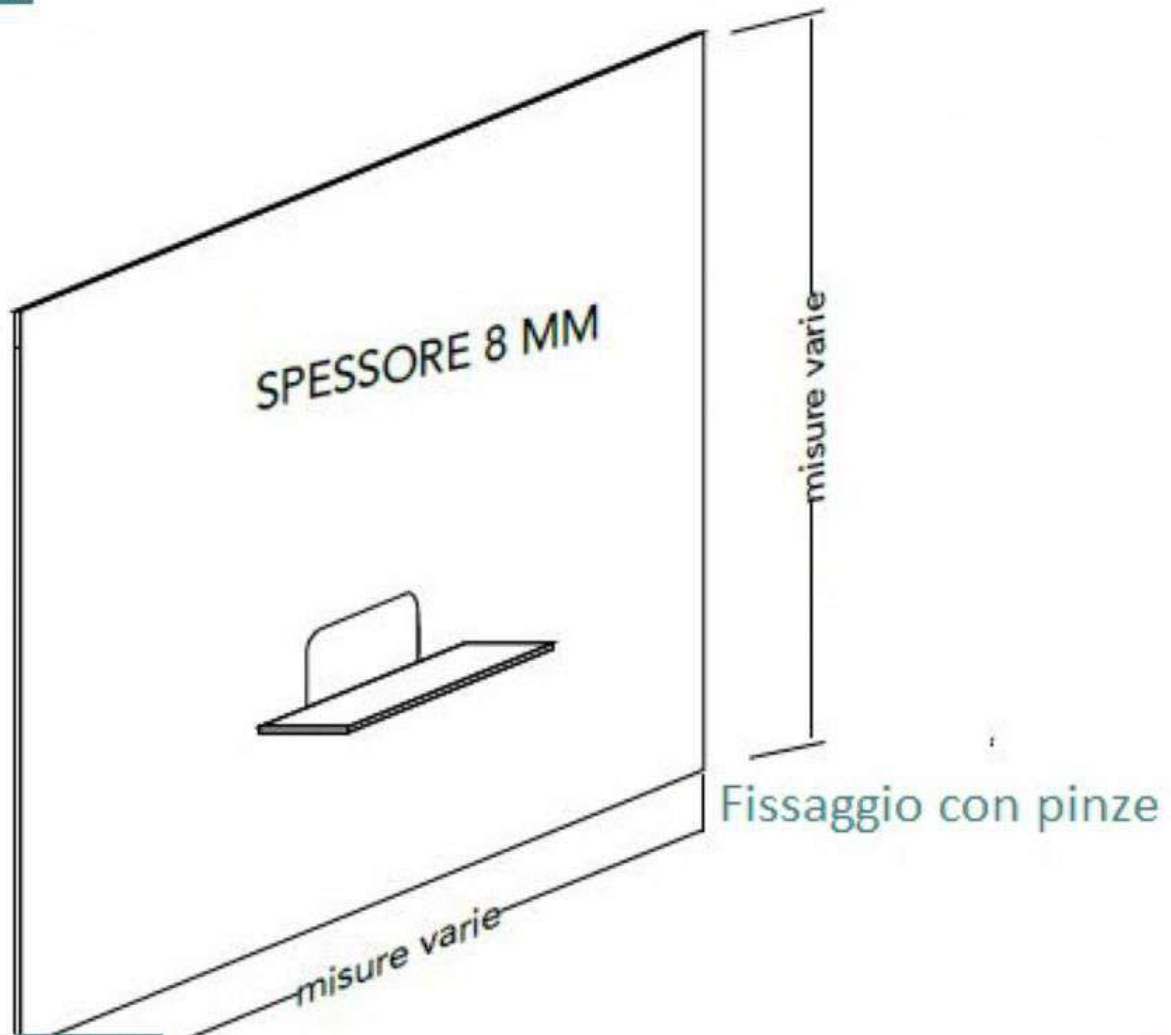

Art.010

FINESTRE
SOLUZIONI

MISURE

● VISTA FRONTALE

● SPESSORE PANNELLO 8 mm

● VISTA LATERALE

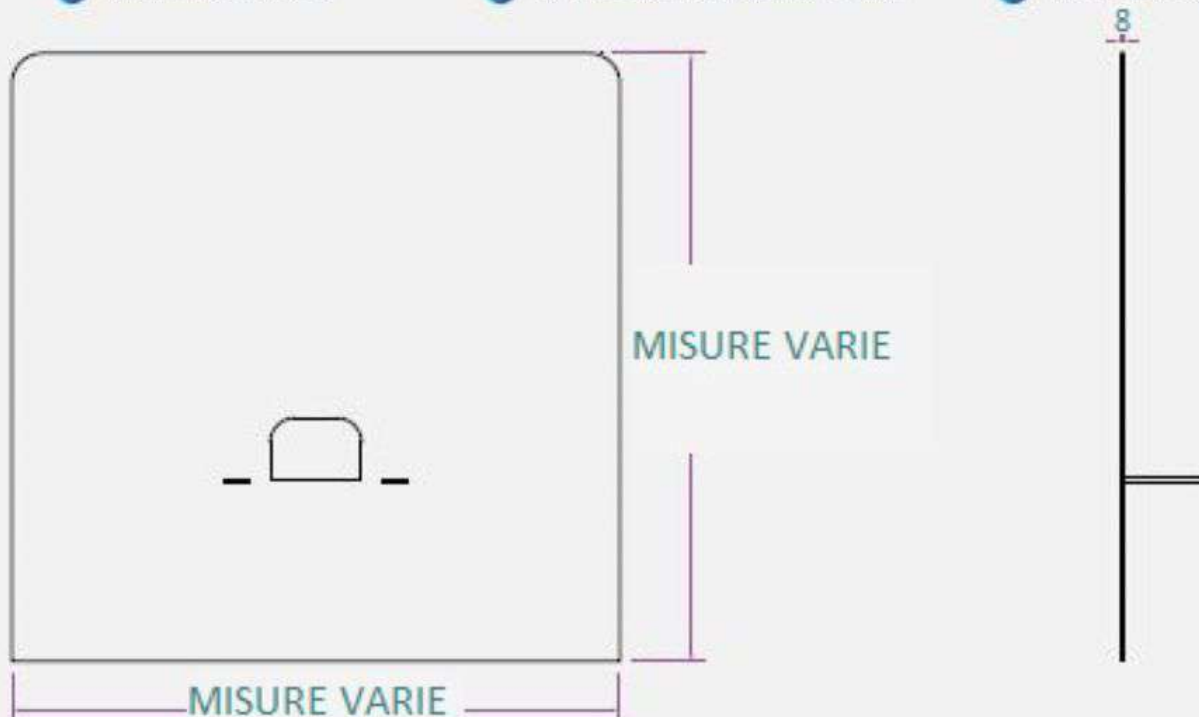

Serie Desk-Business 2

Pag.10

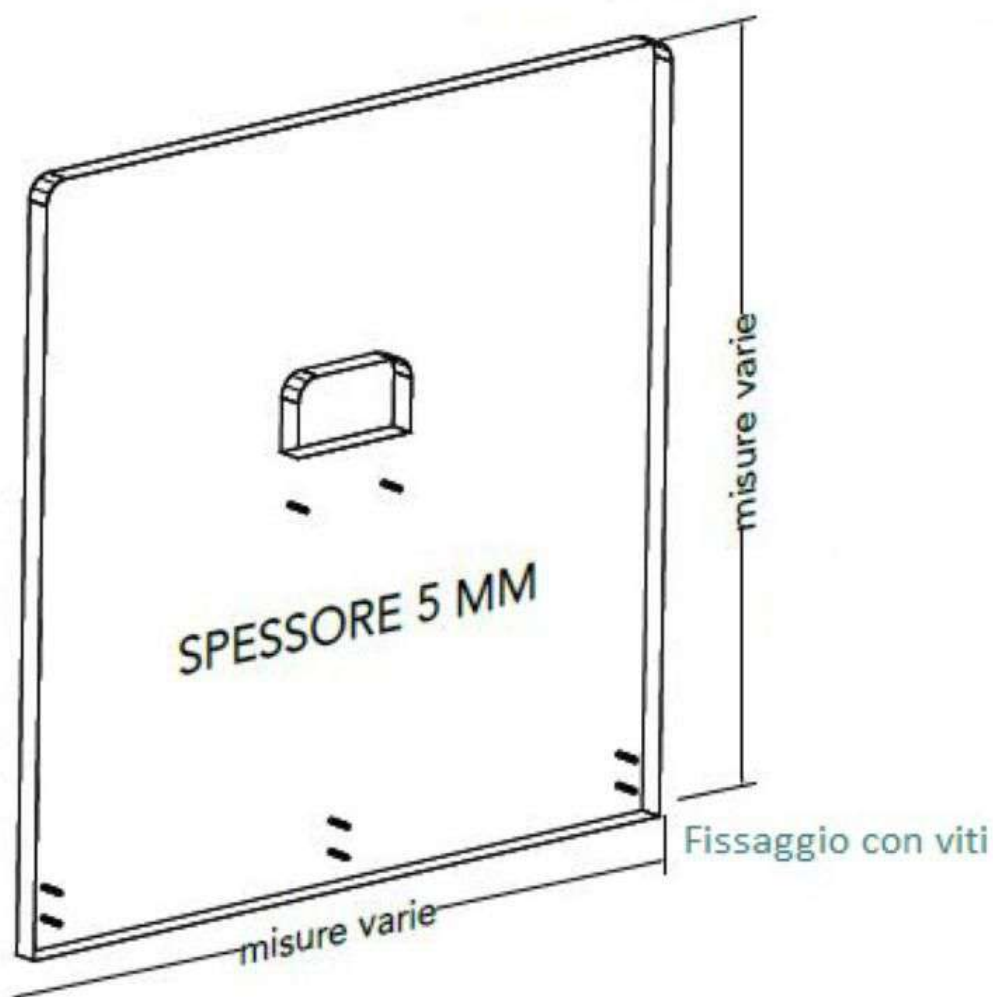

Art.011

FINESTRE
SOLUZIONI

MISURE

● VISTA FRONTALE

● SPESSORE PANNELLO 5 mm

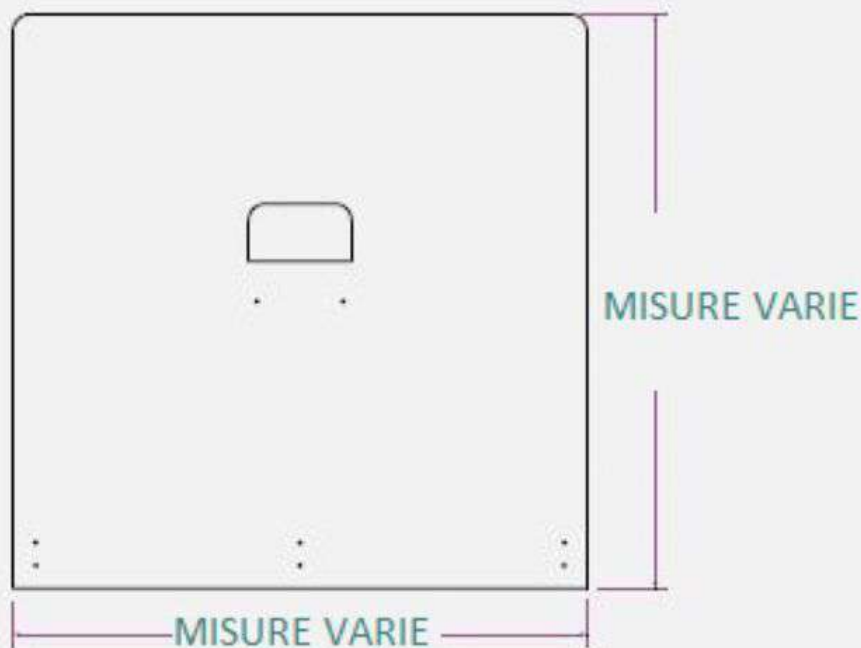

Serie Desk-Estetik

Pag.12

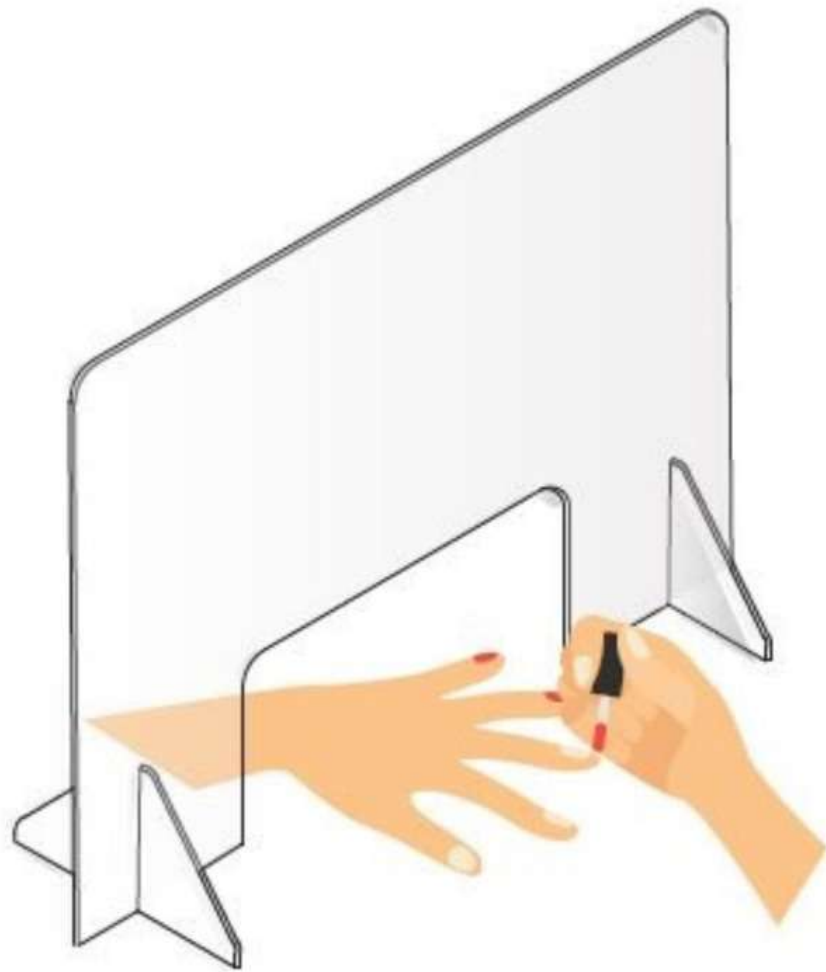

Art.012

FINESTRE
SOLUZIONI

MISURE

● VISTA FRONTALE

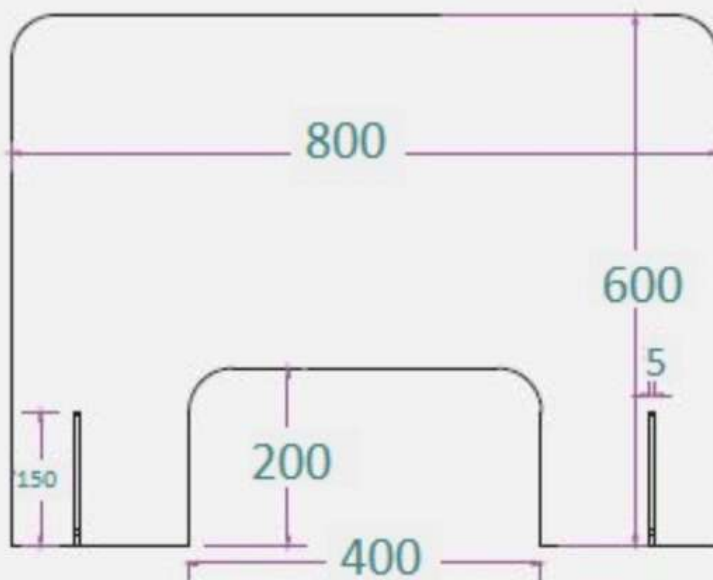

● SPESSORE PANNELLO 5 mm

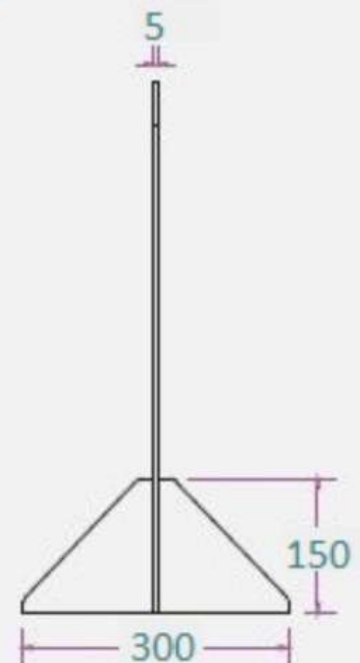

Serie Desk-PRIVACY

Pag.13

Possibilità colori 10mm Alveolare:



VERDE

BIANCO

BLU

BRONZO

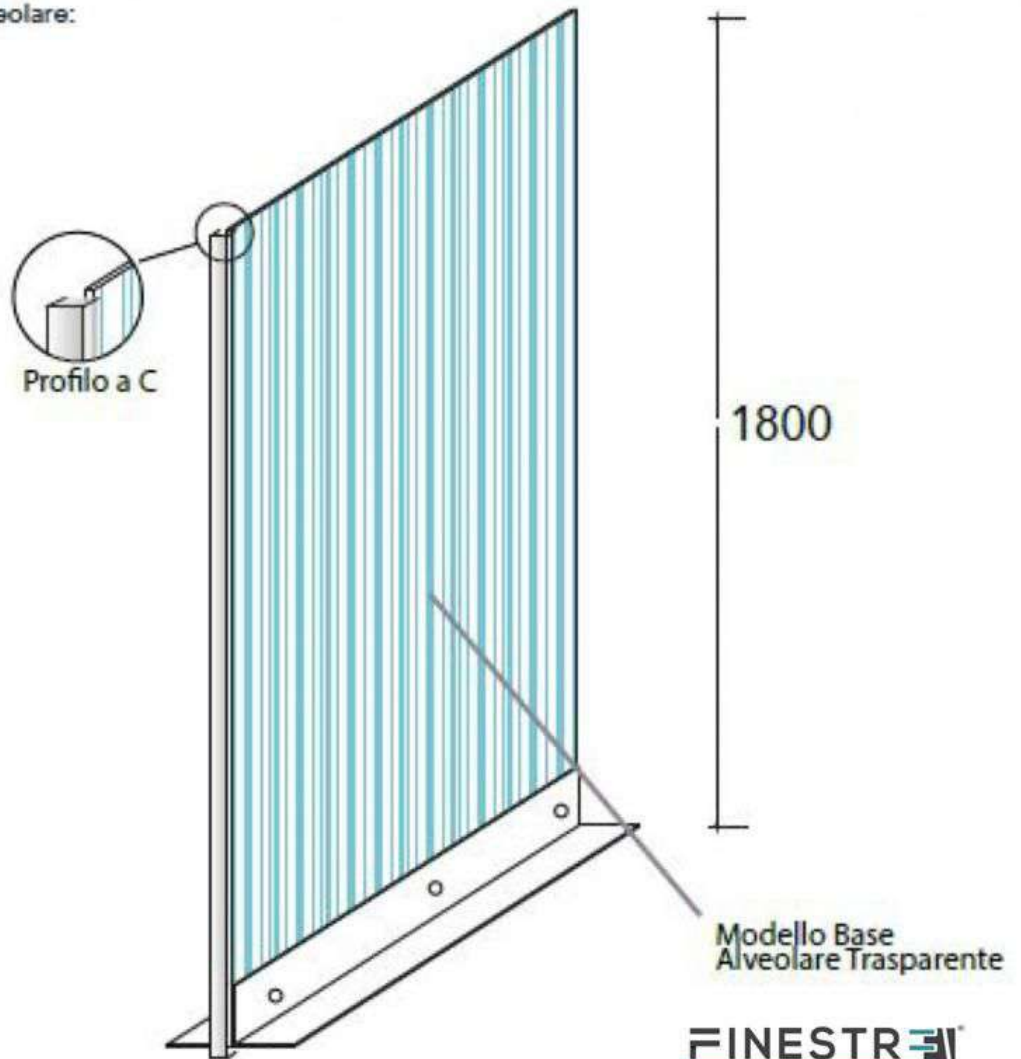

1800

Modello Base
Alveolare Trasparente

FINESTRE
SOLUZIONI

Art.013

MISURE

● VISTA FRONTALE

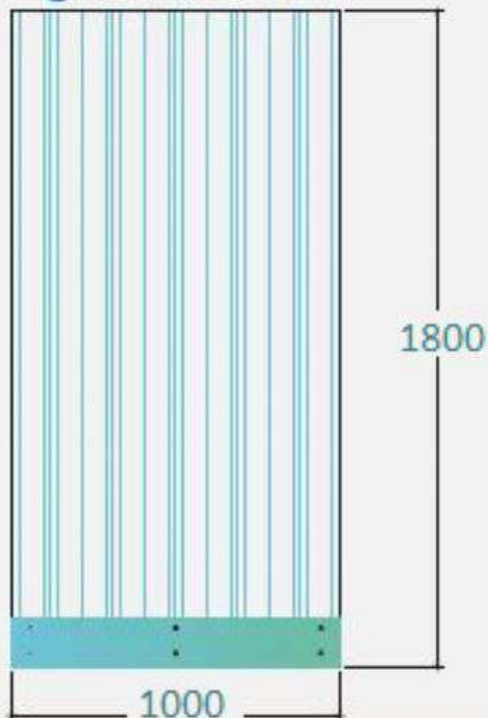

1800

1000

● SPESSORE PANNELLO 10 mm

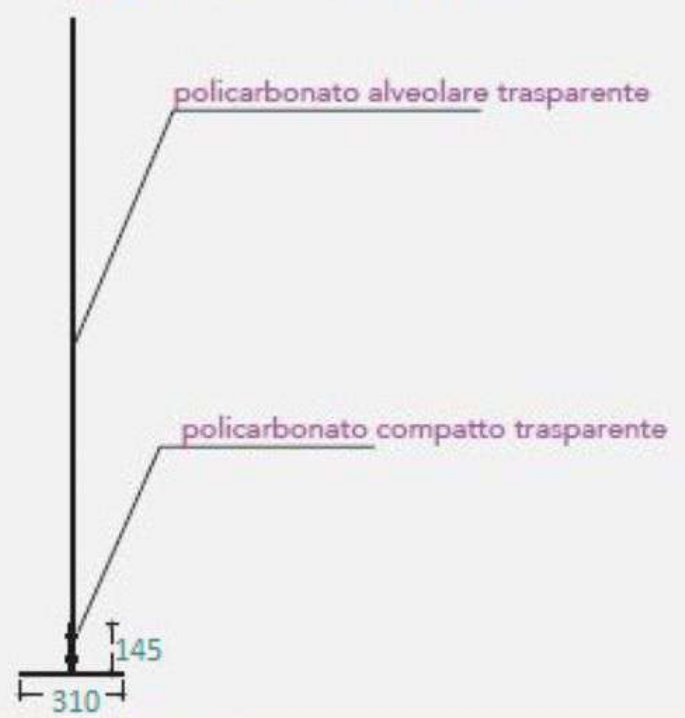

policarbonato alveolare trasparente

policarbonato compatto trasparente

145

310

Serie Desk-Hospital

Pag.14



Art.014

FINESTRE
>SOLUZIONI

● VISTA FRONTALE

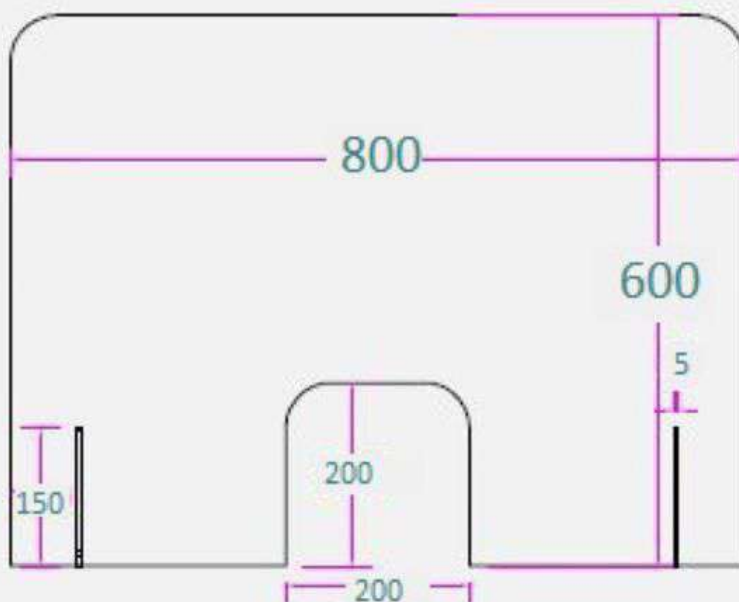

● SPESSORE PANNELLO 5 mm

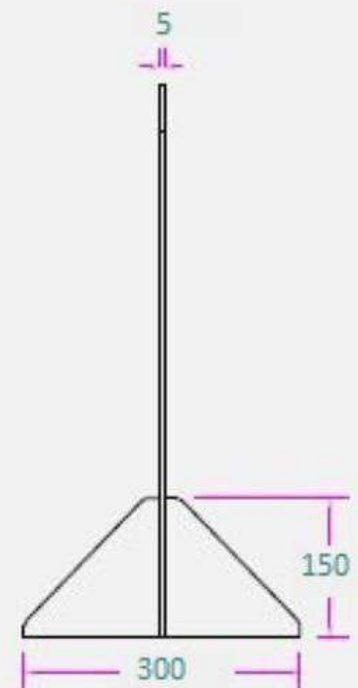

Serie Desk-Hospital 2

Pag.14

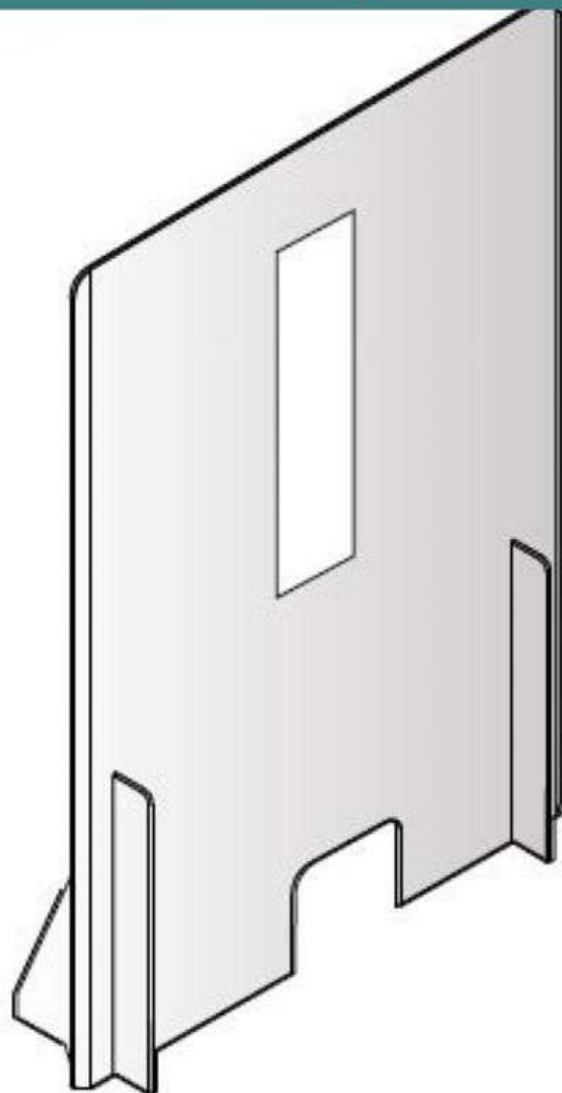

Art.015

FINESTR
SOLUZIONI

● VISTA FRONTALE

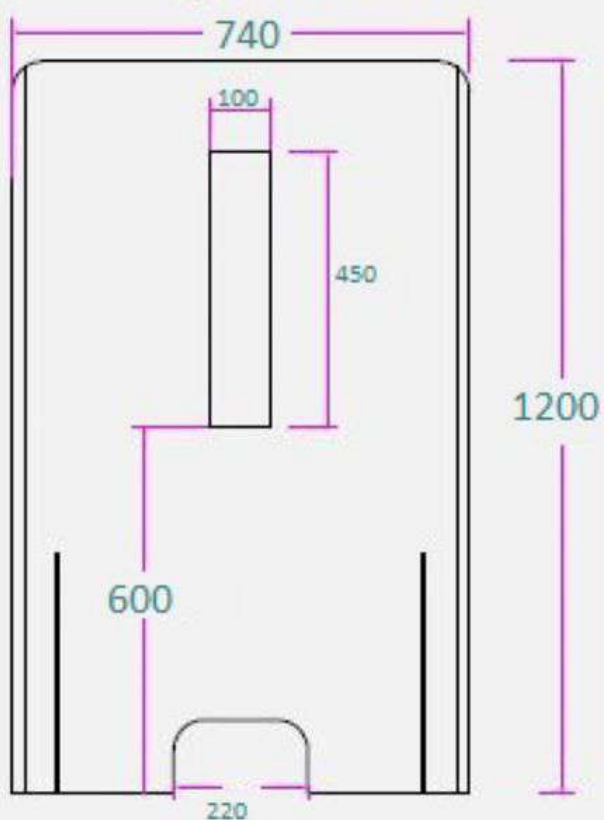

● SPESSORE ANNELLO 5

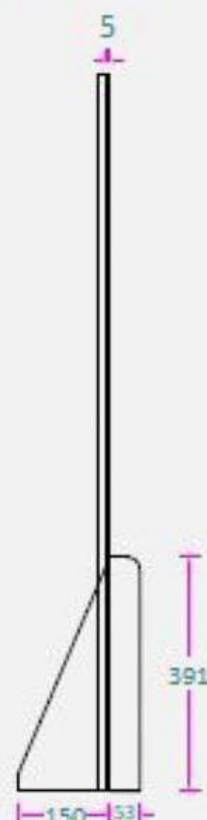

FINESTR [®]
SOLUZIONI

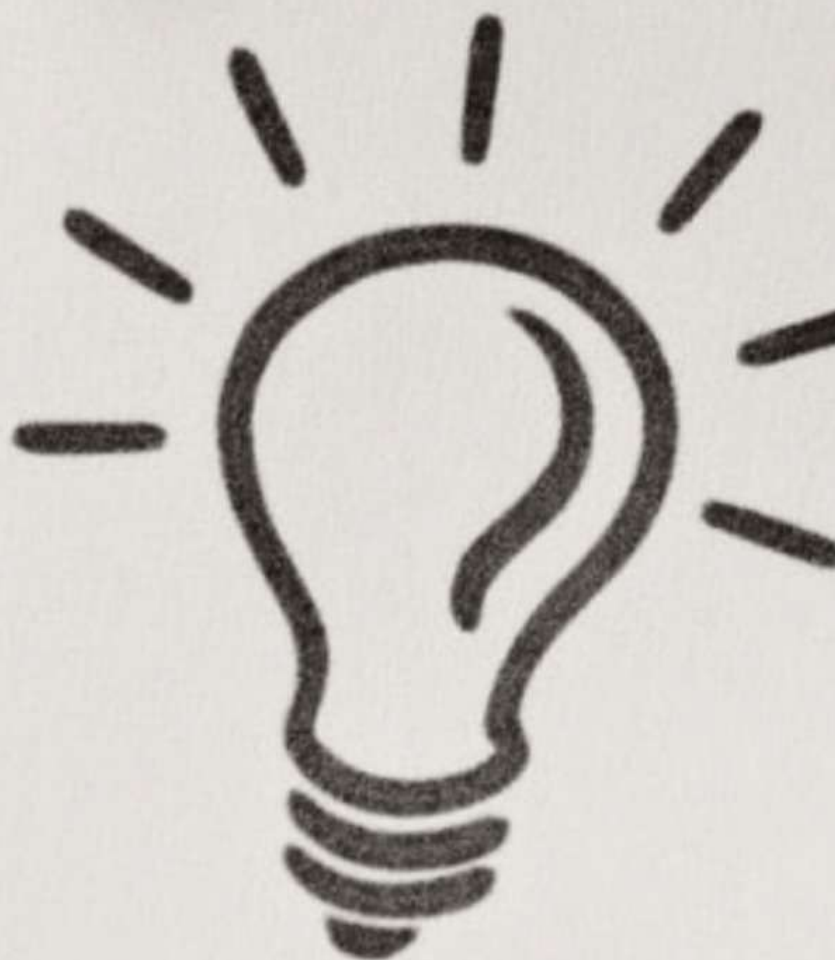

IN CAMPO CONTRO IL COVID-19

Finestre e Soluzioni S.r.l. Viale Elena 142, 80044 Ottaviano (NA)
P.i. 09405531212

INFO@FINESTRSOLUZIONI.IT

081 18102013

350 5053996

WWW.FINESTRSOLUZIONI.IT